

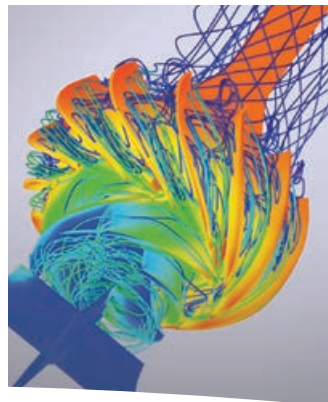

***LNN  
Between Bearings, Axially Split,  
Single-Stage, Double-Suction Pump***



*Experience In Motion*



## **Pump Supplier to the World**

*Flowserve is the driving force in the global industrial pump marketplace. No other pump company in the world has the depth or breadth of expertise in the successful application of pre-engineered, engineered, and special purpose pumps and systems.*

### **Life Cycle Cost Solutions**

Flowserve provides pumping solutions that permit customers to reduce total life cycle costs and improve productivity, profitability and pumping system reliability.

### **Market-Focused Customer Support**

Product and industry specialists develop effective proposals and solutions directed toward market and customer preferences. They offer technical advice and assistance throughout each stage of the product life cycle, beginning with the initial inquiry.

### **Broad Product Lines**

Flowserve offers a wide range of complementary pump types, from pre-engineered process pumps to highly engineered and special purpose pumps and systems. Pumps are built to recognized global standards and customer specifications.

Pump designs include:

- Single-stage process
- Between bearings single-stage
- Between bearings multistage
- Vertical
- Submersible motor
- Positive displacement
- Nuclear
- Specialty

### **Product Brands of Distinction**

*ACEC™ Centrifugal Pumps*

*Aldrich™ Pumps*

*Byron Jackson® Pumps*

*Calder™ Energy Recovery Devices*

*Cameron™ Pumps*

*Durco® Process Pumps*

*Flowserve® Pumps*

*IDP® Pumps*

*INNOMAG® Sealless Pumps*

*Lawrence Pumps®*

*Niigata Worthington™ Pumps*

*Pacific® Pumps*

*Pleuger® Pumps*

*Scienco™ Pumps*

*Sier-Bath® Rotary Pumps*

*TKL™ Pumps*

*United Centrifugal® Pumps*

*Western Land Roller™ Irrigation Pumps*

*Wilson-Snyder® Pumps*

*Worthington® Pumps*

*Worthington Simpson™ Pumps*

**LNN**  
*Between Bearings,  
 Axially Split, Single-Stage  
 Double-Suction Pump*



**Broad Hydraulic Coverage**

*The LNN series of double-suction axially split pumps is available with more than 200 impeller and volute combinations. User industry standards, specifications and references have been incorporated in the rotating element design, with particular emphasis on ease of maintenance. The integrated design philosophy provides optimum parts interchangeability of bearing housings, seal chambers, wear rings and shaft sleeves.*

**Typical Applications**

- Water cooling
  - Cooling tower
  - Circulating
- High and low water lift
- Raw water transfer
- Cargo loading and unloading
- District cooling and heating
- Water pipeline
- Fire protection
- Irrigation
- Crude oil transfer
- Desalination
- Marine services

**Complementary Pump Designs**

Flowsolve also offers the following complementary pumps:

- LR axially split, single-stage pump
- EC axially split, multistage pump
- DVSH ISO 13709/API 610 (BB1) axially split, double-suction, single-stage pump
- DMX ISO 13709/API 610 (BB3) axially split, multistage pump
- VTP vertical turbine pump
- QL vertical, double-suction, double volute pump

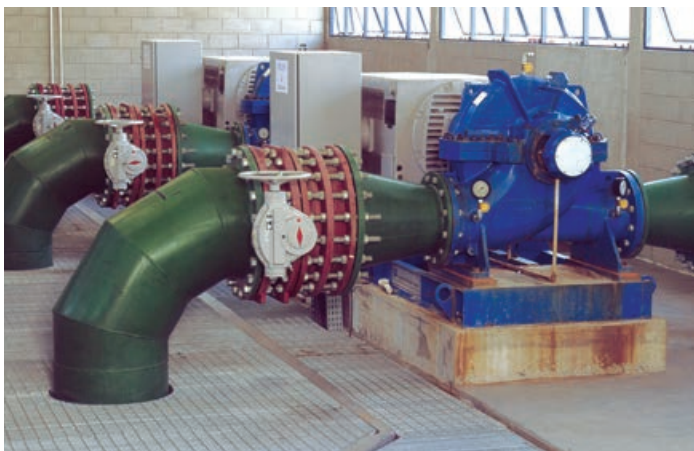

**LNN**  
*Between Bearings,  
 Axially Split, Single-Stage  
 Double-Suction Pump*

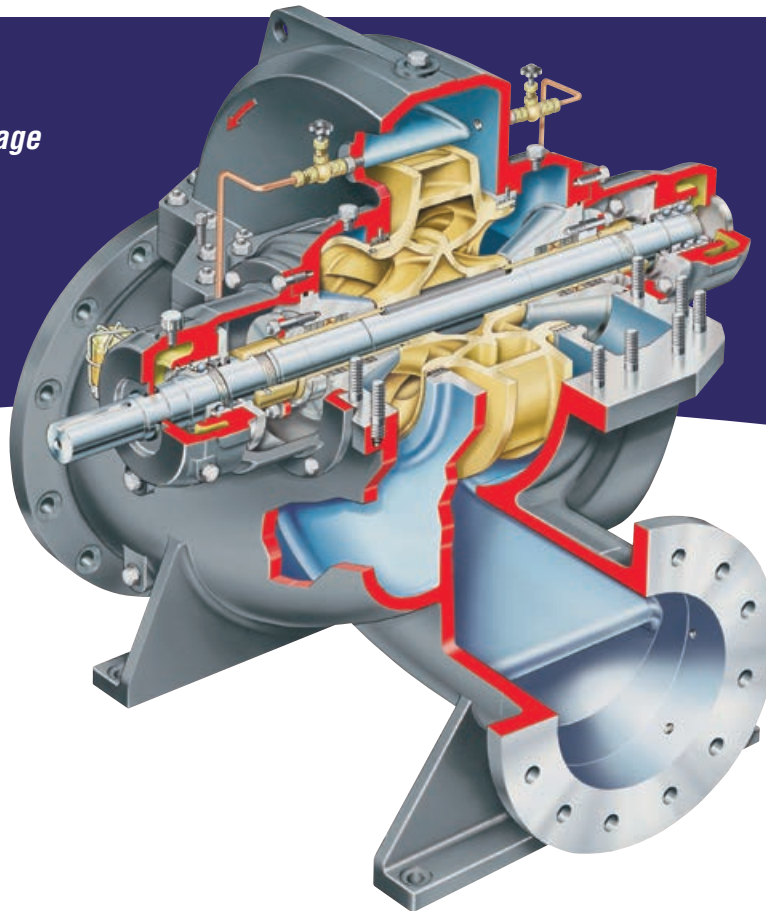

*The LNN series of pumps is the outcome of many years of experience in the design and manufacture of axially split casing pumps. State-of-the-art pump design technology from Flowserve has resulted in superior pump designs which offer broad hydraulic coverage, quiet operation, low NPSH requirements, high operating efficiency and low total cost of ownership.*

**Operating Parameters**

- Flows to 30 000 m<sup>3</sup>/h (132 000 gpm)
- Heads to 300 m (985 ft)
- Pressures to 40 bar (580 psi)
- Temperatures to 140°C (285°F)
- Sizes to 125 mm (5 in) to 1200 mm (48 in)

**Features and Benefits**

**Double Volute Design** minimizes hydraulic radial forces in any condition down to the minimum flow, thereby reducing shaft deflection and increasing the service life of bearings, seals and wear rings.

**Separate 360° Bearing Housings** provide superior bearing stability and shaft support while easing maintenance. Perfect shaft alignment is assured by a full register fit to the casing.

**Axially Split Casing With Suction and Discharge Nozzles** integrally cast in the lower casing half permits pump disassembly without disturbing the piping or driver. Upper casing half does not have to be removed to access bearings, packing, mechanical seals, sleeves or sleeve nuts.

**Nozzle Flanges** meet the dimensional requirements of ASME B16.1, B16.5 or ISO 7005 part 1 or 2. Flanges are available in sizes from Class 125 to Class 300 (ISO PN10 to PN63).

**Standard Labyrinth-type Casing Wear Rings** are positively locked by radial pins. Optional impeller wear rings are shrink fit and pinned securely.

**Precision Cast, Double-suction Impeller** provides hydraulic axial balance with minimal NPSHR and maximal efficiency. The rotor assembly is dynamically balanced to ISO 1940 to assure vibration-free operation.

**Removable, One-piece Seal Chambers** accommodate packing or mechanical seals and are easily converted from one to the other. A four-bolt gland attachment is used with mechanically sealed designs.

**Sleeved Shaft** is amply sized to transmit maximum power and prevent deflection and vibration. Materials range from steel to duplex stainless steel.

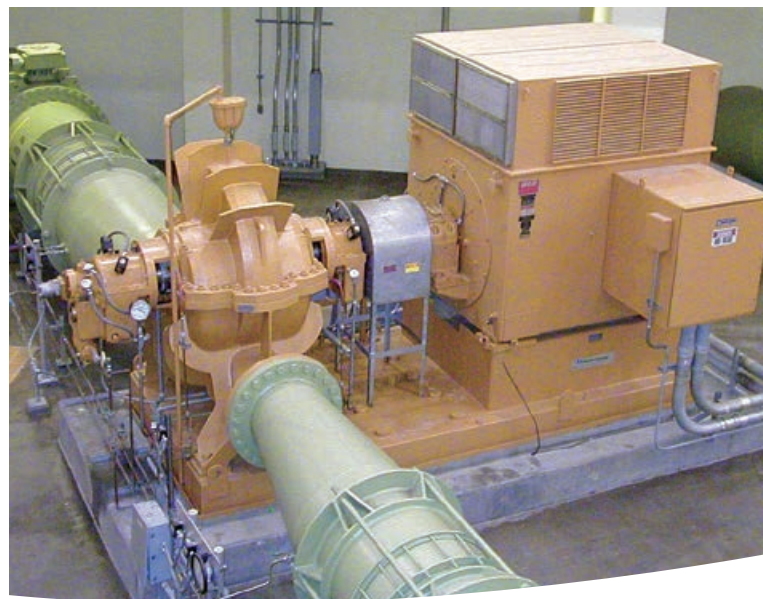

### ***Multiple Bearing Designs***

LNN series pumps are offered with a variety of bearing designs. The standard radial bearing is a self-aligning, single row deep groove design. Depending on size and options, the thrust bearing is either a single row or a double row angular contact type. Grease lubrication is standard.

Options include:

- Oil lubrication (oil bath or oil mist)
- Force feed lubrication system
- “V” ring seal or labyrinth bearing housing seals
- Sleeve radial and ball or tilting pad thrust bearings

FlowsERVE engineers will help select the optimal construction based on ISO/API specifications, the application, and the speed and horsepower rating of the pump.

### ***Materials of Construction***

LNN series pumps are available in a wide range of materials to suit application needs. Available materials range from ASTM A48 cast iron to ASTM A890 duplex and super duplex stainless steels.

### ***Pump Packages***

Pump packages are provided to specification and can include lube oil piping, seal system, monitoring instruments and drive train mounting. Pumps fitted with diesel engine or steam turbine drivers also are available. Baseplate designs may include any of the following:

- Conventional welded steel suitable for grouting
- Skid-type, non-grouted
- Three-point support design
- Pre-grouted
- API designs

### ***Engineered Performance, Reliability and Versatility***

Consisting of a double-suction impeller operating in a double volute casing, the LNN provides optimal hydraulic balance and maximal efficiency over its full operating range.

Multiple impeller designs exist for each casing, offering the flexibility to modify pump performance to meet future service conditions.



**Options and  
Technical Data**

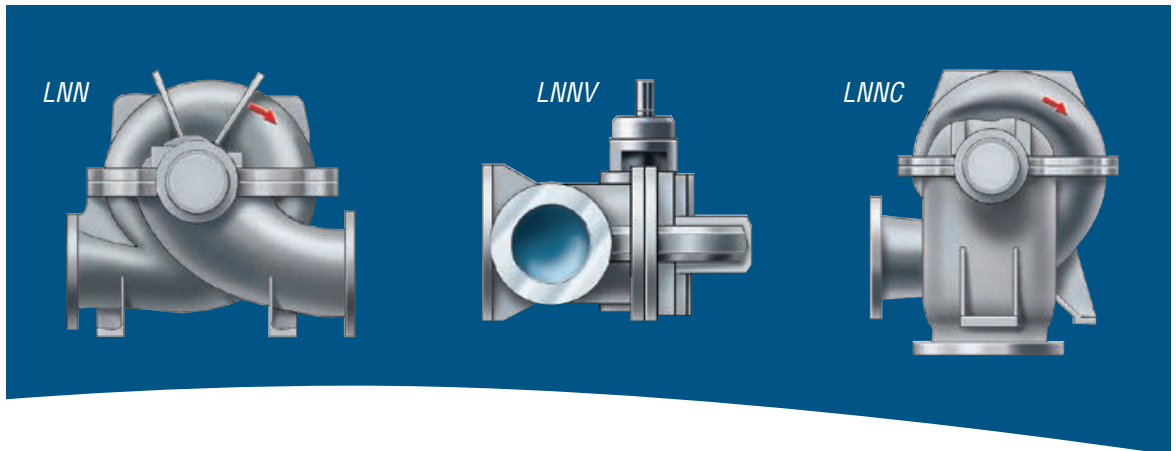

**Available Configurations**

The LNN series pumps are available in numerous configurations and models to suit specific application requirements. The primary models are:

- LNN: Horizontal mounting with side suction and side discharge (standard)
- LNNV: Vertical motor mounting; motor may be mounted on pump or on upper floor with a universal joint (Cardan shaft)
- LNNC: Horizontal mounting with bottom suction and side discharge

The extended LNN series of pumps also includes the following related models:

- LN
- LNH
- LNST
- LNE
- LNS
- LNGT

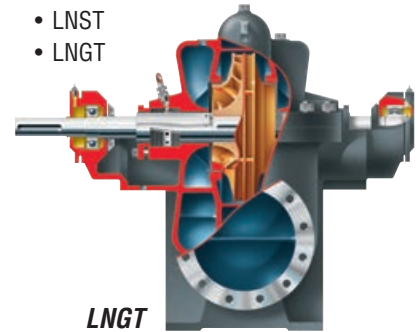

**LNN Range Chart**

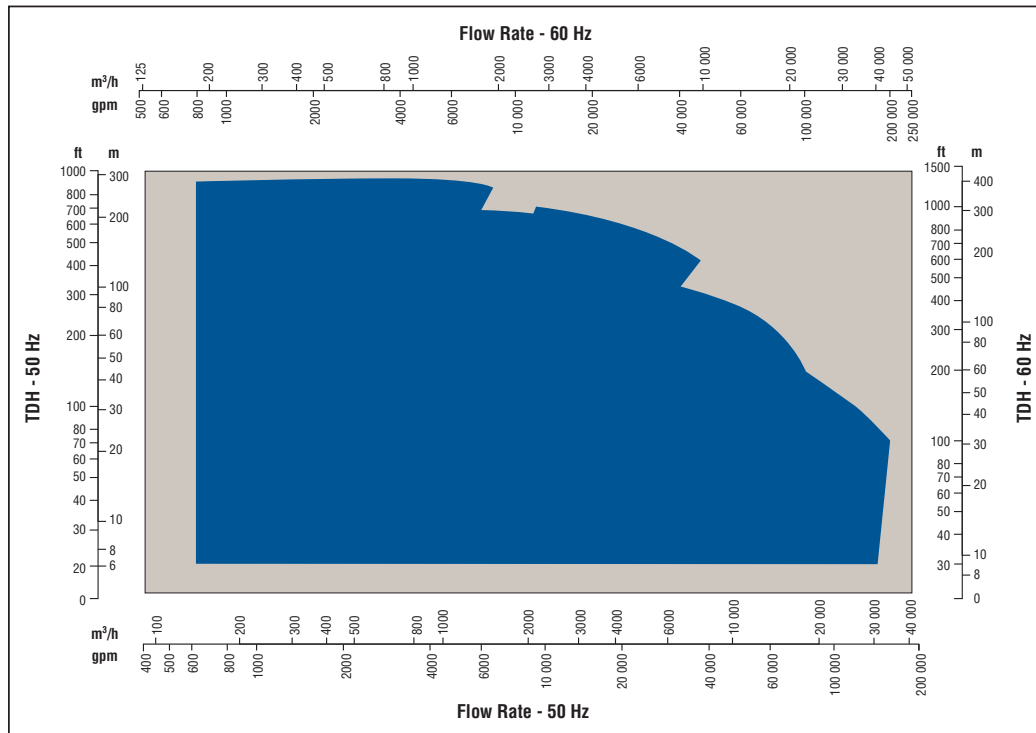

**Global Service and Technical Support**

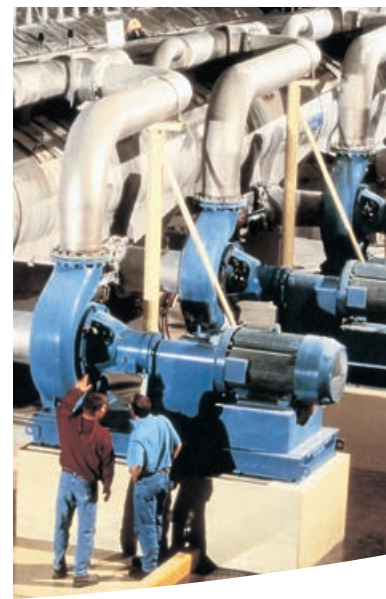

## Life Cycle Cost Solutions

Typically, 90% of the total life cycle cost (LCC) of a pumping system is accumulated after the equipment is purchased and installed. Flowserve has developed a comprehensive suite of solutions aimed at providing customers with unprecedented value and cost savings throughout the life span of the pumping system. These solutions account for every facet of life cycle cost, including:

### Capital Expenses

- Initial purchase
- Installation

### Operating Expenses

- Energy consumption
- Maintenance
- Production losses
- Environmental
- Inventory
- Operating
- Removal

### Innovative Life Cycle Cost Solutions

- New Pump Selection
- Turnkey Engineering and Field Service
- Energy Management
- Pump Availability
- Proactive Maintenance
- Inventory Management

### Typical Pump Life Cycle Costs<sup>1</sup>

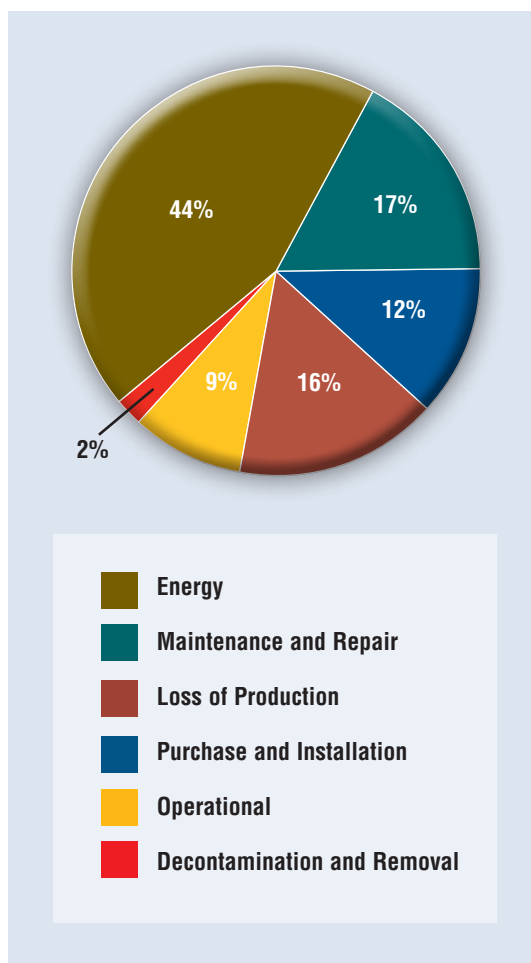

<sup>1</sup> While exact values may differ, these percentages are consistent with those published by leading pump manufacturers and end users, as well as industry associations and government agencies worldwide.

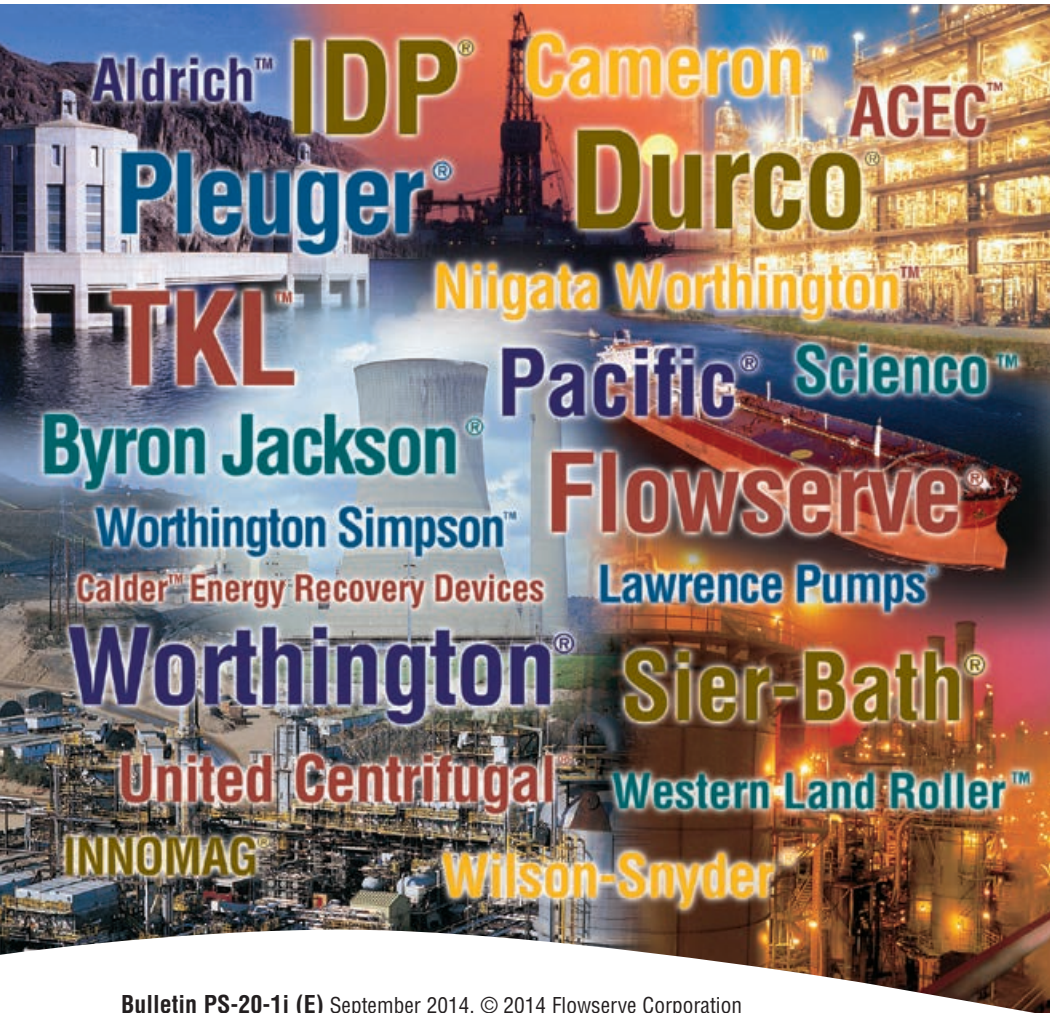

**USA and Canada**

Flowserve Corporation  
5215 North O'Connor Blvd.  
Suite 2300  
Irving, Texas 75039-5421 USA  
Telephone: +1 937 890 5839

**Europe, Middle East, Africa**

Flowserve Corporation  
Parallelweg 13  
4878 AH Etten-Leur  
The Netherlands  
Telephone: +31 76 502 8100

**Latin America**

Flowserve Corporation  
Martín Rodríguez 4460  
B1644CGN-Victoria-San Fernando  
Buenos Aires, Argentina  
Telephone: +54 11 4006 8700  
Telefax: +54 11 4714 1610

**Asia Pacific**

Flowserve Pte. Ltd.  
10 Tuas Loop  
Singapore 637345  
Telephone: +65 6771 0600  
Telefax: +65 6862 2329

Bulletin PS-20-1j (E) September 2014. © 2014 Flowserve Corporation

*To find your local Flowserve representative:*

For more information about Flowserve Corporation,  
visit [www.flowserve.com](http://www.flowserve.com) or call +1 937 890 5839.